



## Cavity Fire Barriers for External Weatherboards

Tenmat's Cavity Fire Barriers are designed to reinstate fire resistance performance within external wall cavities created behind external weatherboard systems.

## Product Description

Tenmat have carried out system specific testing of horizontal and vertical cavity fire barriers for use behind external weatherboard systems.

The FF102/50 Ventilated Cavity Fire Barrier is an open-state cavity barrier, tested to TGD19 for use horizontally only, to maintain an air gap / ventilation and drainage.

The NVFB-WB is a highly compressible, A1 Reaction to Fire Rated stone wool cavity barrier, tested to BS EN 1366-4 with specific fibre orientation that enables effective sealing of cavities vertically even where lapped cladding creates an irregular outer surface.

Both products are suitable for cavities up to 50mm which includes cavities created by 25mm, 38mm and 50mm battens and offer up to 120 minutes integrity and insulation fire resistance (see fire test evidence table for full details and limitations).

In the event of a fire the FF102/50 intumescent material expands to close the air gap behind the weatherboards to reinstate the fire resistance performance, whereas the NVFB-WB provides non-ventilated, full fill fire protection vertically.

## Product Details

### FF102/50

- “Open state” cavity fire barrier for use horizontally
- TGD19 tested following the general principles of BS EN 1363-1
- Fire Rated for up to 120 minutes integrity and insulation
- 3rd Party Certification - IFC Certification
- Cavities up to 50mm wide
- Tested with both lapped and flat weatherboards

### NVFB-WB

- “Full fill” / “closed state” cavity fire barrier for use vertically
- BS EN 1366-4 3rd Party Fire Tested
- Fire Rated for up to 120 minutes integrity and insulation
- Sizes available to suit cavity batten widths of 25, 38 and 50mm
- Tested with both lapped and flat weatherboards



FF102/50 only

## Approved Applications - FF102/50

## FF102/50 "Open State" Cavity Fire Barrier

Tested to the principals of BS EN 1363-1 and in accordance with ASFP TGD19 guidance

Inner Leaf Substrate Type (facing cavity) with Appropriate Minutes (EI) Fire Rating	Outer Leaf Substrate Type (facing cavity) With Appropriate Fire Resistance	Cavity Barrier Orientation	Insulation Type Within Cavity	Maximum Cavity Width (in mm)	Maximum Open State Air Gap (in mm)	Product Dimensions (thickness x height x length in mm)	Product Fire Resistance Rating	
							Integrity	Insulation
OSB on Timber Frame**, Non-combustible board on SFS**** or concrete/masonry	Aerated Concrete, Concrete, Blockwork & Masonry	Horizontal	None	50	44	6 x 75 x 1000	120**	120**
Aerated Concrete, Concrete, Blockwork & Masonry	Hardie® Plank and alternative Weatherboards*** -Lap	Horizontal	None	25 (+8mm)*	19 (+8mm)*	6 x 75 x 1000	120	120
Aerated Concrete, Concrete, Blockwork & Masonry	Hardie® Plank and alternative Weatherboards*** -Lap	Horizontal	None	38 (+8mm)*	32 (+8mm)*	6 x 75 x 1000	120	120
Aerated Concrete, Concrete, Blockwork & Masonry	Hardie® VL Plank and alternative Weatherboards***	Horizontal	None	38	32	6 x 75 x 1000	120	120
Aerated Concrete, Concrete, Blockwork & Masonry	Hardie® VL Plank and alternative Weatherboards***	Horizontal	None	50	44	6 x 75 x 1000	120	120
CP Board on SFS	Mineral Fibre External Wall Slab	Horizontal	None - mineral fibre formed outer substrate	15	9	6 x 75 x 1000	120	120
CP Board on SFS	Mineral Fibre External Wall Slab	Horizontal	None - mineral fibre formed outer substrate	25	19	6 x 75 x 1000	120	120

## 3rd Party Certification

IFC Certification - Certificate No. IFC1753

## Fire Test Evidence

Field of Application Report - PAR/22672/04

International Fire Consultants Ltd (IFC) part of KIWA UK Group

Technical Assessment Report - 4790359356-1

UL International

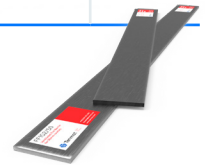

Note: Where the cavity exceeds the above maximum cavity dimensions or for HardiePlank "Hit & Miss" Vertical installations, please contact TENMAT for alternative suitable products.

\*Hardie® Plank, Hardie® VL Plank and other weatherboards are approved with an overlapping detail resulting in a varying cavity size of up to 8mm greater than the timber batten depth.

\*\* The fire rating required on Timber Frame projects would typically be expected to be 30 minutes only. The fire ratings and information provided in this document and supporting fire test evidence is not intended to be a complete specification for the proposed cavity barrier and it is the responsibility of others (the Principal Designer) to ensure that the product/assembly is suitable for the intended purpose.

\*\*\* Approved Weatherboard parameters:

- Material type – Fibre cement board
- Thickness – 8 mm minimum
- Reaction to Fire Class – A2, s1-d0 (or better)

See UL Assessment Report 4790359356-1 for full details.

\*\*\*\* Non-combustible board on steel framed system (SFS) with direct and applicable fire test evidence to demonstrate that it can provide the level of fire resistance, as applicable, when tested to EN 1364-1 or EN 1365-2 with the selected facing material.

Timber Frame inner substrate tested with min. 9mm thick OSB Sheathing Board with a minimum 35mm thick timber stud that must be in place directly behind the sheathing board in line with the cavity barrier.

## Approved Applications - NVFB-WB

## NVFB-WB "Non-Ventilated" Cavity Fire Barrier

## Fire Test Performance to BS EN 1366-4

Inner Leaf Substrate Type (facing cavity) with Appropriate minutes Fire Rating	Outer leaf Substrate Type (facing cavity) With Appropriate Fire Resistance	Cavity Barrier Orientation	Batten Size	Max. Cavity including lapped detail	NVFB-WB Thickness (in mm)	NVFB-WB Width (in mm)	Product Fire Resistance Rating	
							Integrity	Insulation
Aerated Concrete, Concrete, Blockwork & Masonry	Hardie® Plank and alternative Weatherboards*** - Lap	Vertical	25	33	40*	100	120	60
Aerated Concrete, Concrete, Blockwork & Masonry	Hardie® Plank and alternative Weatherboards*** - Lap	Vertical	38	46	50*	100	120	60
Aerated Concrete, Concrete, Blockwork & Masonry	Hardie® Plank and alternative Weatherboards*** - Lap	Vertical	50	58	60	100	120	60
Aerated Concrete, Concrete, Blockwork & Masonry	Hardie® Plank and alternative Weatherboards*** - Lap	Vertical	25	33	50*	100	120	120
Aerated Concrete, Concrete, Blockwork & Masonry	Hardie® Plank and alternative Weatherboards*** - Lap	Vertical	38	46	60*	100	120	120
Aerated Concrete, Concrete, Blockwork & Masonry	Hardie® Plank and alternative Weatherboards*** - Lap	Vertical	50	58	75	100	120	120
Aerated Concrete, Concrete, Blockwork & Masonry	Hardie® VL Plank	Vertical	25	25	40*	100	120	120
Aerated Concrete, Concrete, Blockwork & Masonry	Hardie® VL Plank	Vertical	38	38	50*	100	120	120
Aerated Concrete, Concrete, Blockwork & Masonry	Hardie® VL Plank	Vertical	50	50	60	100	120	120

Fire Test Evidence:

Fire Test Report WF534907B

\* NVFB-WB thickness approved based on the direct field of application rules in BS EN 1366-4 which covers smaller joint widths from that tested provided the degree of compression (%) exerted on the seal is equal to or greater that that used in the test.

Note: Aerated Concrete, Concrete, Blockwork and Masonry of density 670 kg/m<sup>3</sup> or greater are approved.





## Technical Information - FF102/50

Property	FF102/50														
Free Expansion	26:1 Ratio														
Colour	Silver														
Finish	Aluminium Foil														
Cuttability	Can be cut to length														
Working Life	60 years (see below)														
Long Term Storage Conditions	Dry, ambient														
Transportation Storage Temperature	-20°C to +70°C														
Durability	Type X intended for use in conditions exposed to weather (UV, rain, frost)														
Smoke/Halogen Content	Low Smoke / Zero Halogen														
Minimum Total Working Life (Years)	Based on typical climatic conditions														
	<table> <tr> <td>UK</td> <td>60 years</td> </tr> <tr> <td>Australia</td> <td>45 years</td> </tr> <tr> <td>France</td> <td>60 years</td> </tr> <tr> <td>New Zealand</td> <td>60 years</td> </tr> <tr> <td>Germany</td> <td>60 years</td> </tr> <tr> <td>Hong Kong</td> <td>40 years</td> </tr> <tr> <td>The Netherlands</td> <td>60 years</td> </tr> </table>	UK	60 years	Australia	45 years	France	60 years	New Zealand	60 years	Germany	60 years	Hong Kong	40 years	The Netherlands	60 years
UK	60 years														
Australia	45 years														
France	60 years														
New Zealand	60 years														
Germany	60 years														
Hong Kong	40 years														
The Netherlands	60 years														

## Standard Sizes

6mm (thick) x 75mm (wide) x 1000mm (long)

## Technical Information - NVFB-WB

Property	NVFB-WB
Colour	Buff/Beige
Finish	Plain Fibre
Cuttability	Can be cut to length
Reaction to Fire	A1
Working Life	60 years (see below)
Long term storage conditions	Dry, ambient
Transportation Storage Temp	-20°C to +70°C
Durability	The fire performance of mineral wool does not deteriorate with time. The Euroclass classification of the product is related to the organic content, which cannot increase with time.

## Standard Sizes

40mm x 100mm x 1200mm  
 50mm x 100mm x 1200mm  
 60mm x 100mm x 1200mm

## Non Standard Sizes

75mm x 100mm x 1200mm

Note: ROCKWOOL stone wool is durable by nature. Sample testing from existing buildings shows that the stone wool retains its performance for at least 65 years\* without being affected by compression or temperature or humidity changes. (\* FIW, Durability Project Mineral Wool 2016)

This performance is dependent upon correct and appropriate usage as stated in any installation instructions and manufacturer guidance, appropriate attachment and protection of the product, high standard of workmanship during the installation and the product not being disturbed or damaged after installation.

## Pre Installation

The principal designer must approve the use of any cavity barrier, in conjunction with the products fire test reports, taking full account of the whole construction of the external wall systems and components, including any requirements of Building Regulations and or NHBC Standards.

Before the Tenmat FF102/50 and NVFB-WB are recommended by Tenmat, the following information is required to ensure that the suggested product is considered suitable for the intended application, by Tenmat, within the construction as indicated by the client.

- Project name, location and postcode.
- Building height and use (as per ADB V1/2 2020).
- Fire resistance period/rating required. Integrity and Insulation.
- Composition and construction of external walls, both inner and outer substrates.
- Total external wall cavity size. (Maximum distance from outer face of inner substrate to inner face of inner substrate including tolerances/profiles).
- Type and thickness of cavity insulation if present.
- What ventilation gap is required horizontally?
- Are non-vented cavity barriers required vertically?
- Quantity required to complete project?
- When will materials be required?
- Name and role of person completing form.

When the above information is obtained then this can be cross referenced with the full range of Tenmat cavity barriers to ensure that the product recommended, by Tenmat, is considered suitable for consideration by the principal designer.

## General considerations for the principal designer

In most circumstances the horizontal barrier should be installed uninterrupted in a continuous line. In certain situations, installation in between vertical battens has been tested (see technical detail drawings). The installation of the NVFB-WB vertically must take priority and be installed first with the FF102/50 fitted either side of the vertical cavity barrier.

The principal designer must sanction any interruptions, which may include items such as brackets, rails or battens, that may affect the continuous line of the cavity barrier. The principal designer must consider the combustibility, melting points and the shape of any interruptions, that are likely to prevent the cavity barrier performing as tested or as expected in the projects design.

If there are interruptions/obstructions that prevent the cavity barrier being fitted in a continuous line, and with sanction from the principal designer, the product may be cut with a sharp knife and tightly butted up against any obstructions and then restarted on the opposite side of the obstruction. The obstruction must not create a void which the cavity barrier can not expand into.

Intumescent cavity barriers are tested and designed to expand outwards, from the face of the intumescent material only, additional design details will be required to account for external corners.

The cavity barrier should not be penetrated by anything other than the mechanical fixings which are used to fix the cavity barrier to the building.

The cavity barrier should be installed onto a flat surface, with no gaps behind the cavity barrier, the maximum space in front of the cavity barrier should not be greater than 44mm (or less depending on construction, see cavity size and air gap details in fire test evidence table).

The Tenmat technical team should be consulted in any instance where the principal designer is uncertain as to any issues which may impede the ability of the cavity barrier to perform as expected.

Ensure the installation area is free from dust, oil and any corrosive material.

Check the mounting substrate is solid and free from cracks and degradation before beginning.

Technical Drawings FF102/50 only

Typical Detail behind Hardie® VL Plank and other generic weatherboards



FF102/50 between battens (stop start)

Typical Detail behind lapped Hardie® Plank and other generic weatherboards (between battens)



Recommended installation:



FF102/50 continuous through battens

It is recommended to ensure the cavity barrier is installed continuously without interruption wherever possible.

Typical Detail behind Hardie® Plank and other generic weatherboards

FF102/50 fitted either side of battens (tightly butted) but NOT behind battens

FF102/50 fitted continuously between interrupted battens

Max. distance to the back of the cladding 33/46mm  
Max. Air Gap 27/40mm  
(from front face of FF102/50)

Max. Air Gap 32/44mm  
(from front face of FF102/50)

Max. distance to the back of the cladding 33/46mm  
Max. Air Gap 27/40mm  
(from front face of FF102/50)

Max. Air Gap 32/44mm  
(from front face of FF102/50)

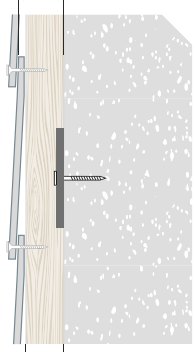

Timber Batten 25/38mm

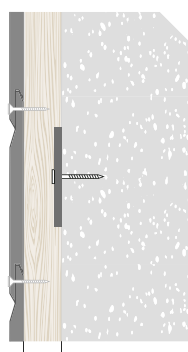

Timber Batten 38/50mm

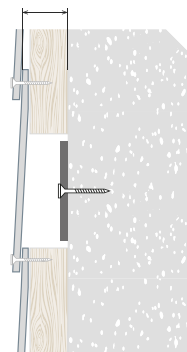

Timber Batten 25/38mm

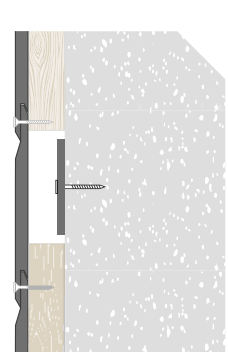

Timber Batten 38/50mm



Installation Instructions  
- FF102/50

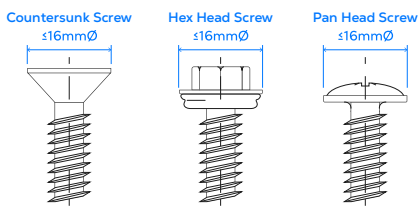
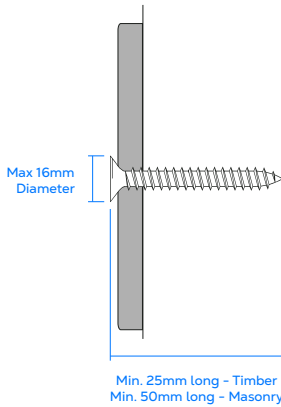
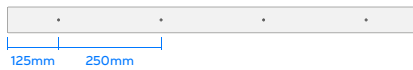

Affix the product using stainless steel screws at a maximum spacing of 250mm and max. 125mm from any strip end with a maximum head diameter of 16mm.

(Screws can be countersunk, hex head and with integrated washer as long as the overall diameter is max. 16mm. Integrated washers with rubber gasket seal also tested).

Fixing lengths should be suited to the substrate with a recommended minimum fixing depth of 50mm in masonry and 25mm into timber unless otherwise specified by the fixing manufacturer.

Tighten any fastenings until the head is just touching the product, it should not be overtightened as this may damage the strip.

When attaching to a solid substrate ensure that the fixings are along the centre line of the fire barrier and the labelled side is facing out into the cavity. (So that you can read the label once the fire barrier is installed).

Position the first screw fixing at a maximum 125mm from one end, continue to face fix through at maximum 250mm centres (4 screws per linear metre), ensuring that the final fixing is a maximum 125mm from the end of the cavity barrier. This will ensure that face fixings are positioned at 250mm centres across the continuous run of cavity barrier.

Where sections of cavity barrier are less than 1 linear metre in length, ensure that face fixings are positioned at a maximum 125mm from each end with additional fixings being positioned at maximum 250mm centres between the end fixings.

For cut sections of cavity barrier less than or equal to 250mm in length only one fixing is required, positioned centrally, ensuring the end of the strip is tightly abutted to adjacent strip/substrate to prevent rotation. If adding additional lengths, ensure they are tightly butted up against each other.

Lapped Plank

Flat Plank

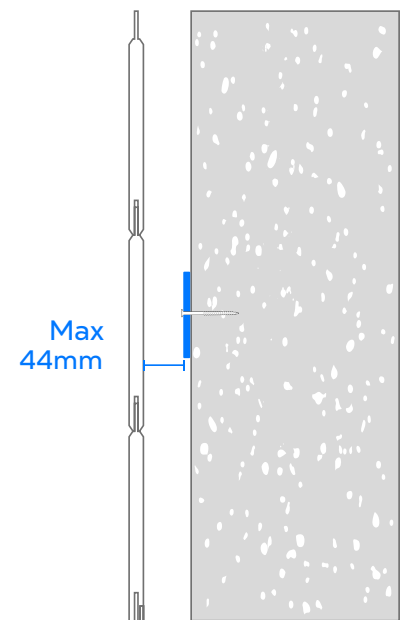
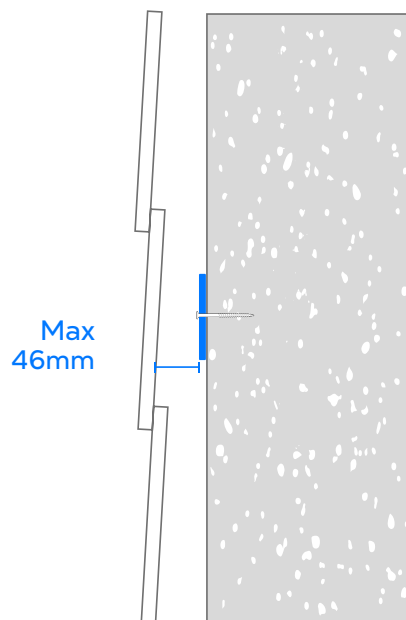

Installation Instructions  
- NVFB-WB

Position the first screw fixing through the centre line of the face of the cavity barrier at a maximum 150mm from one end, continue to face fix through at maximum 450mm centres (3 screws per 1.2 metre length), ensuring that the final fixing is a maximum 150mm from the end of the cavity barrier.

Fix using max. 25mm diameter stainless steel penny washers or stainless steel screws sufficient to hold in place prior to installation of weatherboards.

Ensure the fixings are recessed into the NVFB-WB so as to allow the required compression behind the weather boards. The NVFB-WB should not be overly compressed at the fixing point by more than 5mm more than the compression level.

Recessed screw to allow correct compression (see fire test table)

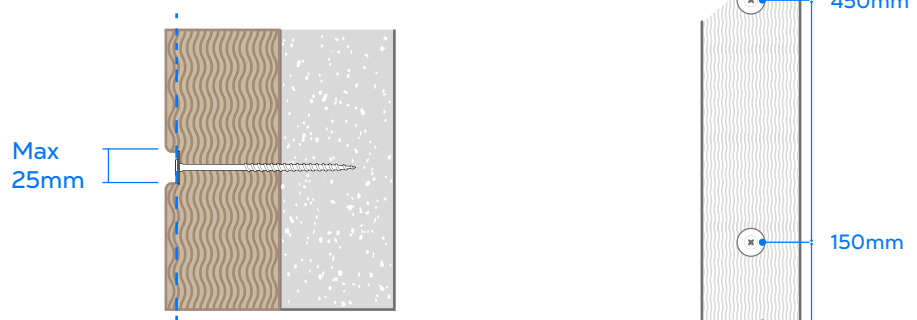

Dotted Line = Compression Zone

Fixing Detail for Shorter Lengths

Where sections of cavity barrier are less than 1.2 metres in length, ensure that face fixings are positioned at a maximum 150mm from each end. For cut sections of cavity barrier less than or equal to 300mm in length only one fixing is required. For cut sections 301 to 500mm then 2 fixings should be used distanced equally from each end.

For installation behind lapped weather boards, the NVFB-WB should be slit horizontally to a depth of approx. 10mm in line with the top of each plank to allow the cavity barrier to fit into lapped cladding profile

Ensure all gaps behind the lapped planks are fully sealed by the NVFB-WB

For installation behind Hardie VL Plank / flat weather boards, no slitting of NVFB-WB required

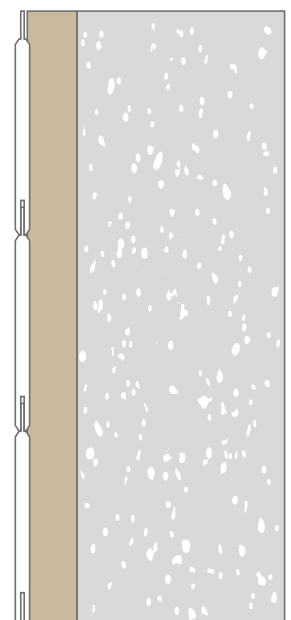
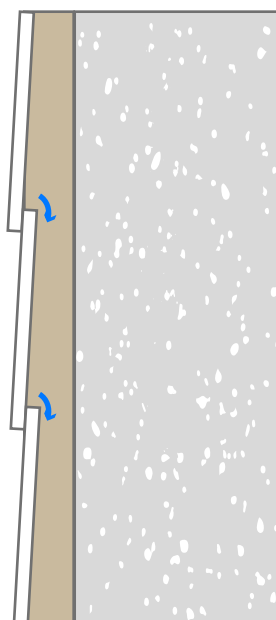
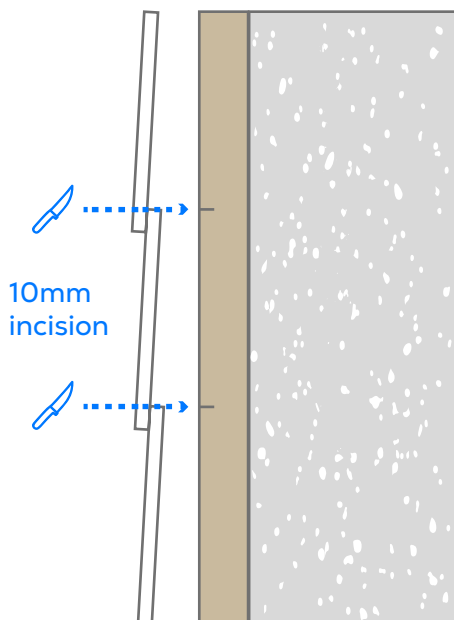

---

### Intended Use

As a cavity barrier, within external wall cavities requiring permanent (open-state) ventilation (FF102/50 horizontally only) or non-ventilated (NVFB-WB vertically), to reinstate fire resistance performance of uninsulated cavities of up to 50mm, in fire conditions.

For cavities greater than 50mm or that fall outside the fire test evidence scope, please contact TENMAT for alternative product solutions.

---

### Maintenance

No active maintenance required, where alterations are made around the product it should be checked visually to ensure that the product is still installed as per the approved original design and fitting instructions at the time of original installation.

---

### Storage

- Take care not to exceed safe working loads and heights for storage shelves and racks
- 

### Tools Required

- Sharp Knife
  - Measuring Tape
  - FF102/50 only - Stainless Steel Screws or Nails with a maximum head diameter of 16mm
  - NVFB-WB only - max. 25mm penny washer and screw fixing (both stainless steel)
  - Appropriate drill for fixing type if using screws
- 

### PPE Required

- Hand protection
- Eye protection

# FF102/50 & NVFB-WB

---

Tenmat Ltd.  
Northbanks Industrial Park,  
Irlam, Frank Perkins Way,  
Greater Manchester,  
M44 5EW

+44 161 872 2181  
fpsales@tenmat.com

tenmat.com



Advanced materials.  
tenmat.com



Part of the  
Diamorph Group

Tenmat warrants the materials it produces will conform to Tenmat specifications and approved drawings where applicable. It is entirely the customer's responsibility to make the final product choice and satisfy themselves of the suitability of the product for the intended application, carrying out testing where required. For construction projects, all products which the customer is intending to use on a particular project must be approved in writing by the customer's building designer, system designer or design control professional, to ensure compliance with the latest regulations.

The information contained in Tenmat data sheets is presented in good faith. Tenmat Limited makes passive fire protection product suggestions based solely upon and limited to the information made available to Tenmat. Tenmat possesses knowledge of fire test data and offers manufacturers installation advice. Within reason, Tenmat is skilled at offering opinion concerning the installations in question, and can comment on interfaces with other construction materials, but this is not a recommendation or decision. Decisions on overall building fire strategy are not made by Tenmat. Tenmat products have been tested for a wide range of construction types, and they must be only used in accordance with Tenmat test evidence. Each specific Tenmat product must be installed into a construction that matches the corresponding test report. Tenmat product performance requires safe and proper handling and correct installation.