



**PREMIER BUILDING
PRODUCTS Ltd**

FITTING DETAILS - ALL PRODUCTS - PBP MS

GUIDE

2021

PREMIERBUILDINGPRODUCTS.CO.UK

+44 (0)1428 654781

enquiries@pbp.uk.com

masonry solutions

GRP for the built environment ■ ■ ■

Fitting Details

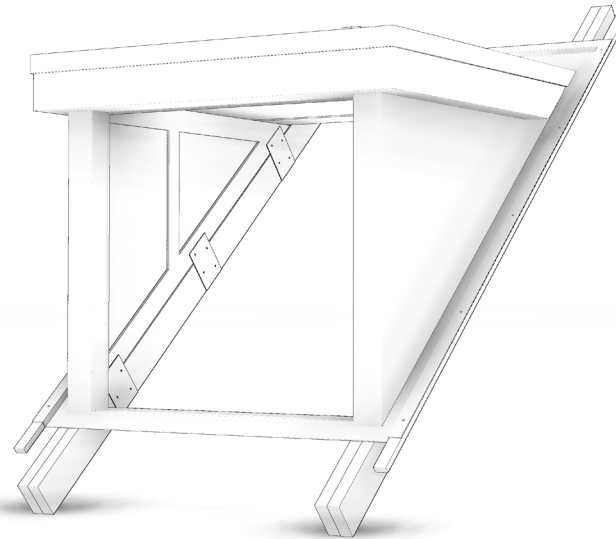
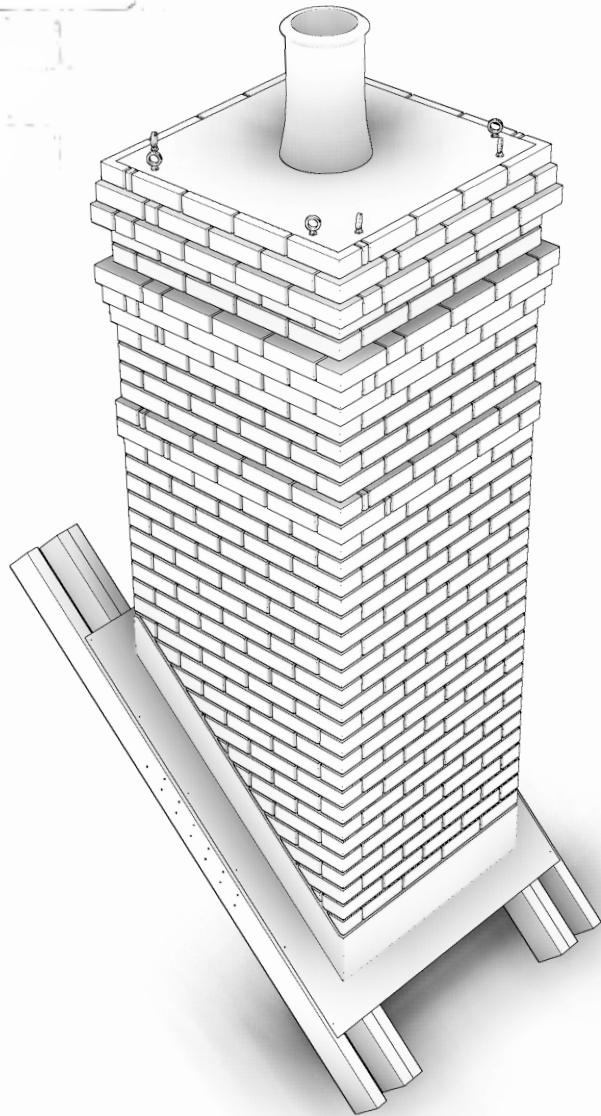

masonry solutions

GRP for the built environment



Chimneys

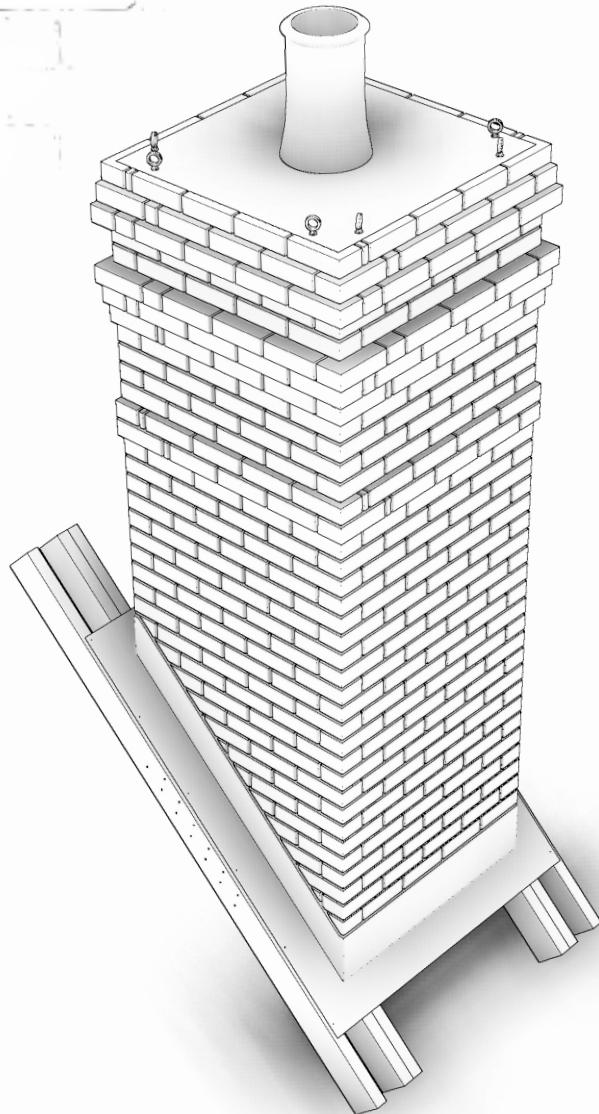

1. Lift Chimney into position using lifting strop round corbel

* Do not lift round capping as this may cause damage

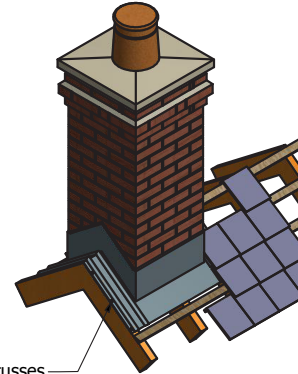
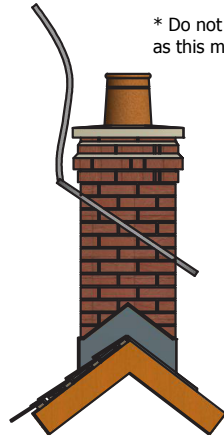

2. Fix through Apron into trusses
Use Fixings provided

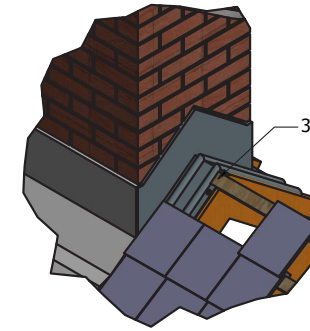

3. Run tile lath upto first rain channel

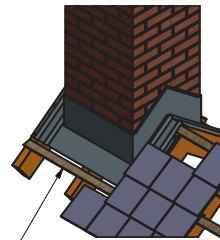

4. Run fillet below apron to create kick for lead

5. Run apron into channel
in accordance with LSA guidelines

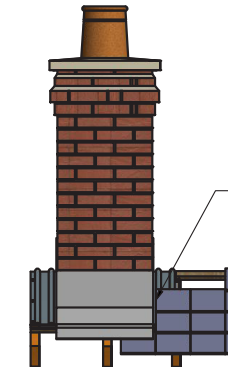
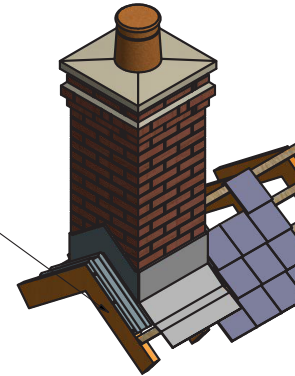

6. Run tiles up to second rain channel
leave 15mm clearance for wash away

GRP general tolerance unless otherwise stated to be +/- 5mm per 1000mm length.

Masonry Solutions

Tel +44(0)1827 250238
Fax +44(0)1827 230765
technical@masonrysolutions.co.uk
www.masonrysolutions.co.uk

Copyright Masonry Solutions 2013
Company Registration No. 5190844.

Information

GRP Chimney Fitting Details
Double rain channel

DESIGNED BY peterms	CHECKED BY	APPROVED BY	DATE	DATE 31/07/2013	Drawing Type FD
------------------------	------------	-------------	------	--------------------	--------------------

GRP Chimney

Fixing Details

Double Rain Channel	ISSUE	SHEET 1 / 1
---------------------	-------	----------------

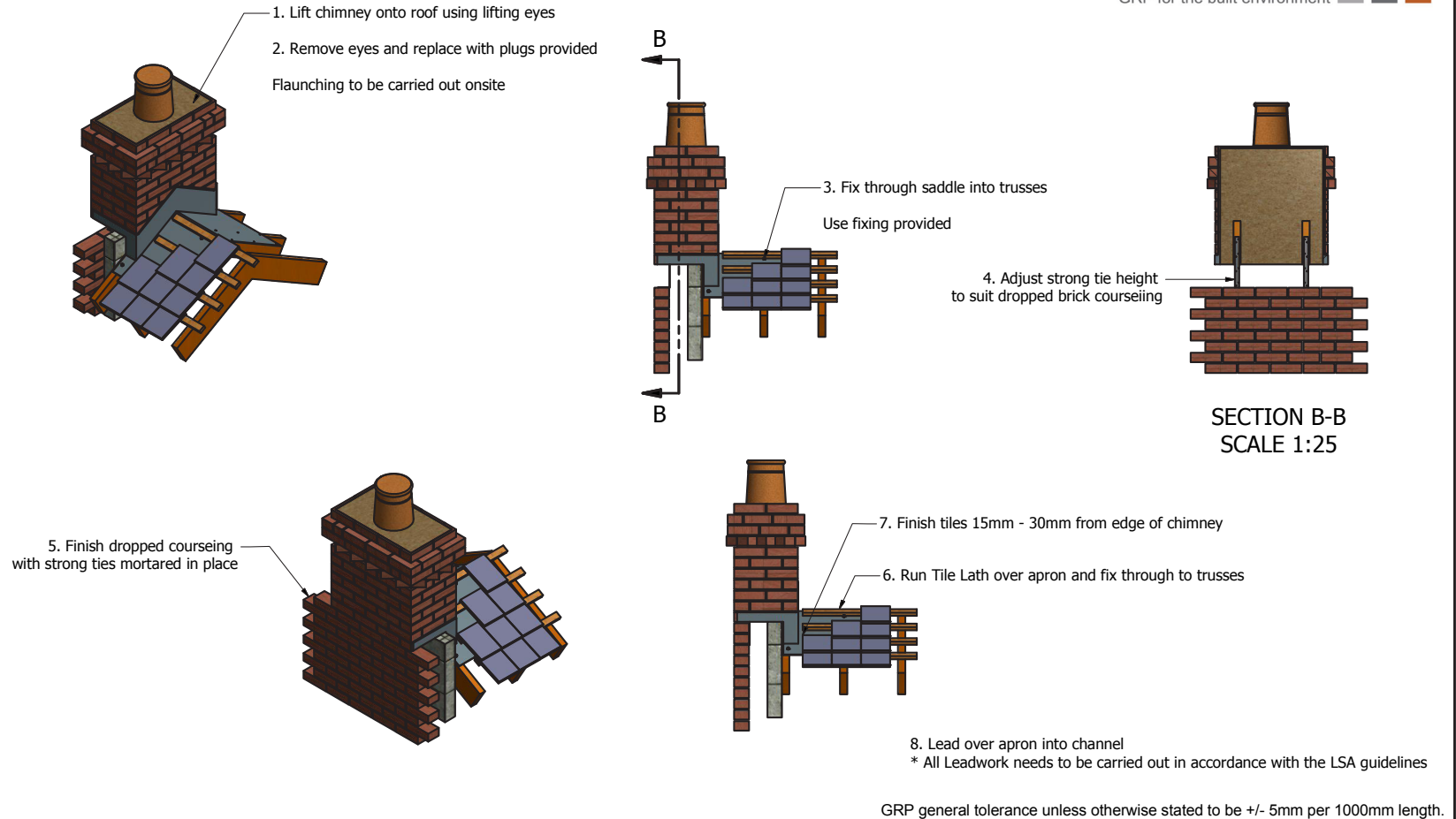

Masonry Solutions

Tel +44(0)1827 259238
Fax +44(0)1827 280765

technical@masonrysolutions.co.uk
www.masonrysolutions.co.uk

Copyright Masonry Solutions 2013
Company Registration No. 5190844.

Information

Fitting Details Gable Chimney

DESIGNED BY
petperms

CHECKED BY

APPROVED BY

DATE

DATE
02/08/2013

Drawing Type
FD

Gable End

Fitting Details

Chimney

ISSUE

SHEET
1 / 1

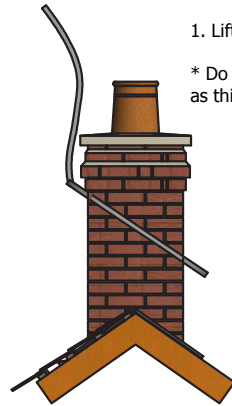

1. Lift Chimney into position using lifting strap round corbel

* Do not lift round capping as this may cause damage

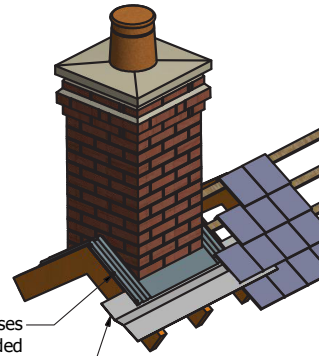

2. Run Lead under chimney 100mm Min.

3. Fix through Apron into trusses
Use fixings provided

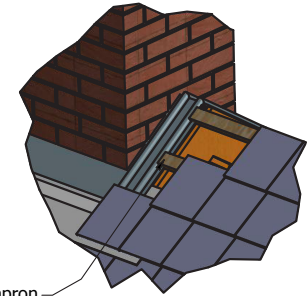

4. Run tile lath over apron
upto first rain channel



5. Run fillet below apron to create kick for lead

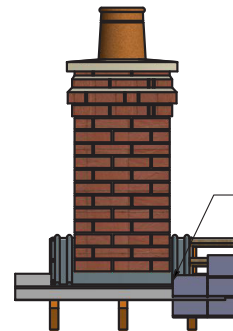

6. Run tiles to edge of second rain channel



7. Dress Lead up fillet and over tiles

GRP general tolerance unless otherwise stated to be +/- 5mm per 1000mm length.

Masonry Solutions

Tel +44(0)1827 250238
Fax +44(0)1827 230765
technical@masonrysolutions.co.uk
www.masonrysolutions.co.uk

Copyright Masonry Solutions 2013
Company Registration No. 5190844.

Information

GRP DV Fitting Details

Double Rain Channel

DESIGNED BY

peterns

CHECKED BY

APPROVED BY

DATE

DATE

30/07/2013

Drawing Type

FD

GRP Developer Chimney

Fixing Details

double rain channel

ISSUE

SHEET

1 / 1

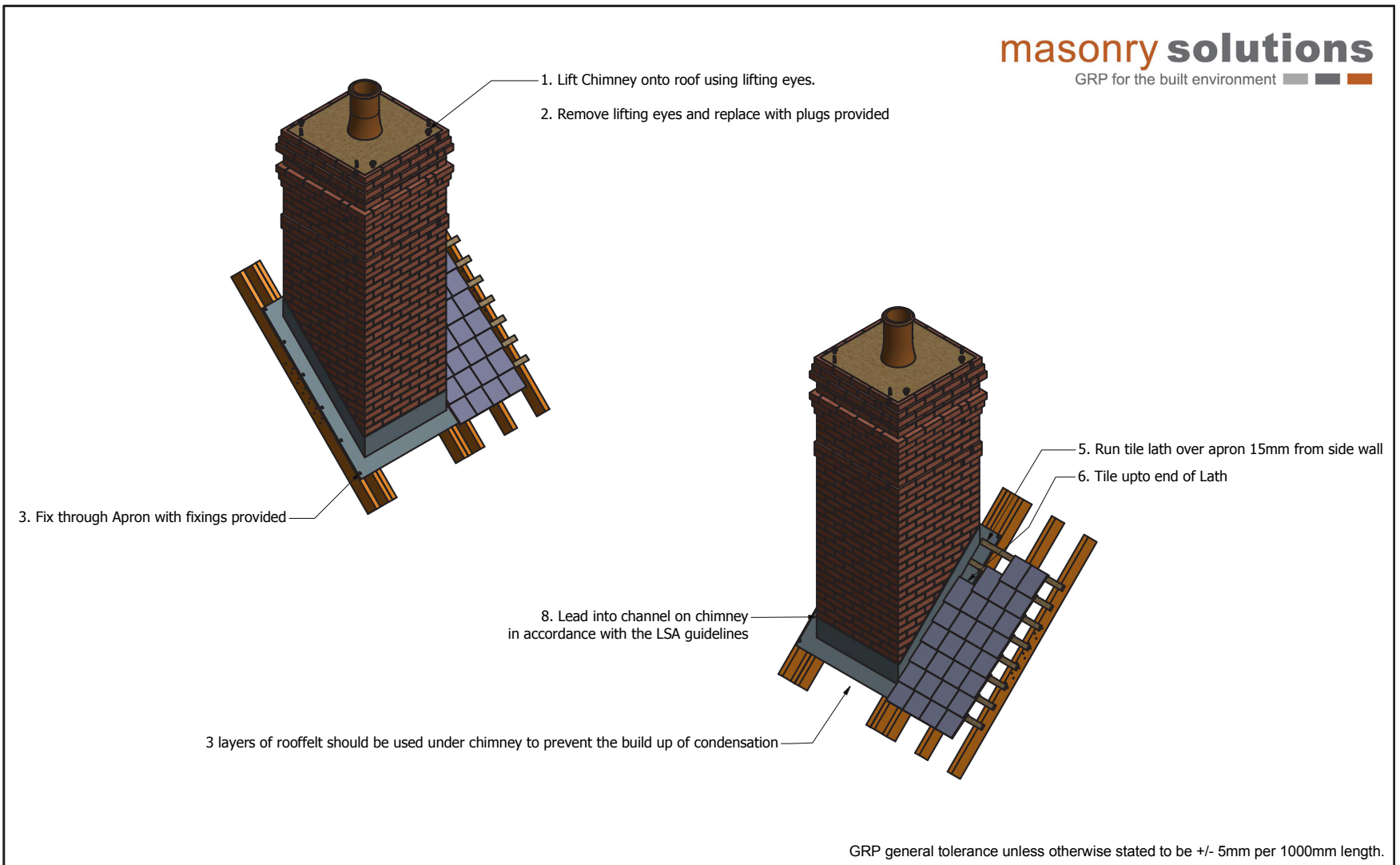

Masonry Solutions Tel +44(0)1827 230238 Fax +44(0)1827 230765 technical@masonrysolutions.co.uk www.masonrysolutions.co.uk Copyright Masonry Solutions 2013 Company Registration No. 5190844.	Information		DESIGNED BY	CHECKED BY	APPROVED BY	DATE	DATE	Drawing Type
	Prefabricated Brick Slip Chimney		peterms				31/07/2013	FD
			Brick Slips Chimney			Fitting Details		
					Prefab	ISSUE	SHEET 1 / 1	



masonry solutions

GRP for the built environment ■ ■ ■

Canopies

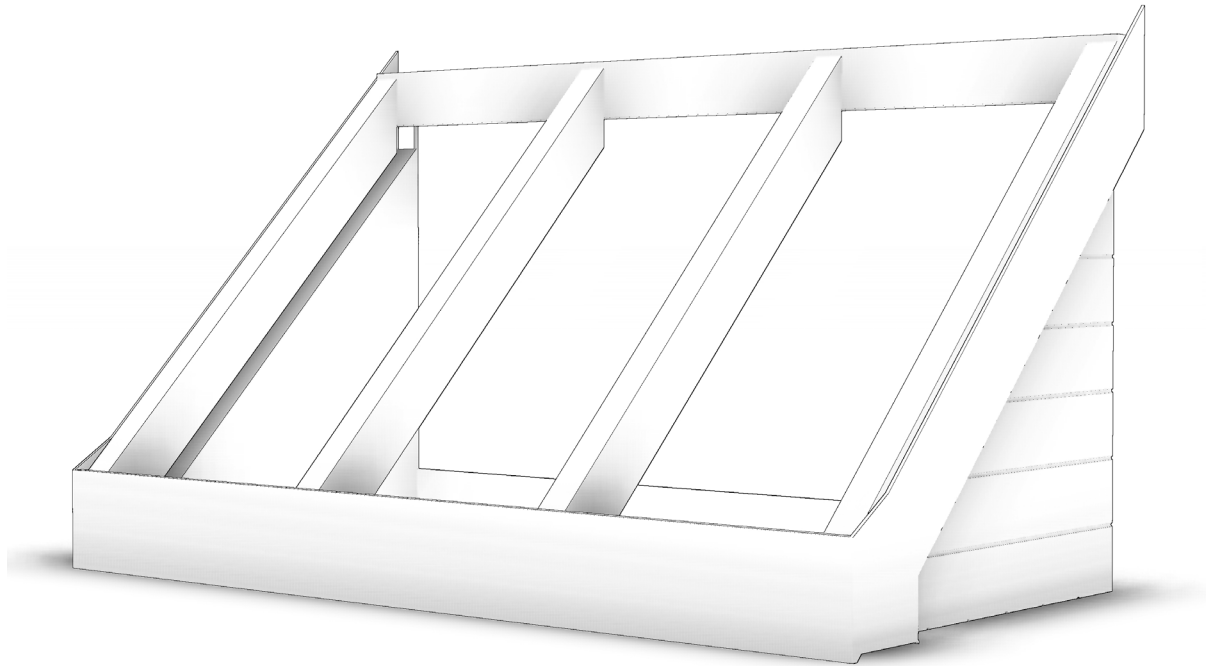

1. Site fix batten to wall

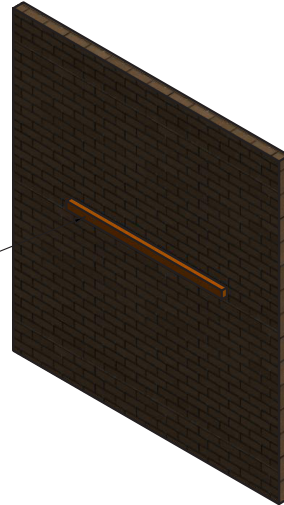

2. Position product to batten

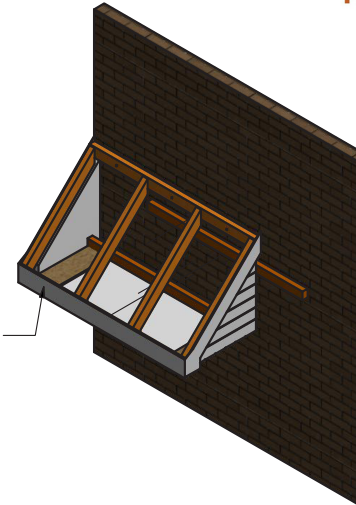

3. Fix through trusses to Masonry
Use M10 x 100mm + Plugs

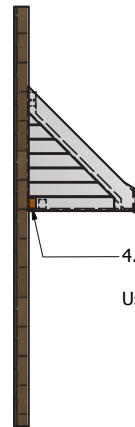

4. Fix through under side of Canopy into Wall plate
Use M8 x 50mm Fixings + Caps

* Tiling and lead work to be carried out in accordance with the LSA guidelines

GRP general tolerance unless otherwise stated to be +/- 5mm per 1000mm length.

Masonry Solutions

Tel +44(0)1827 230238
Fax +44(0)1827 230765
technical@masonrysolutions.co.uk
www.masonrysolutions.co.uk

Copyright Masonry Solutions 2013
Company Registration No. 5190844.

Information
Fitting Details Trussed Canopy

DESIGNED BY peterms	CHECKED BY	APPROVED BY	DATE	DATE 31/07/2013	Drawing Type FD
------------------------	------------	-------------	------	--------------------	--------------------

Trussed Canopy

Fitting Detail

Onsite tiling

ISSUE
SHEET
1 / 1

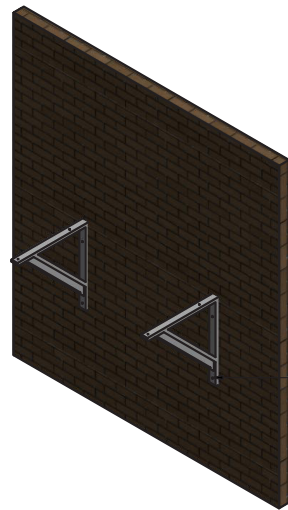

1. Fix gallow brackets to wall
Use M10 x 100mm + Caps

3. Fix through Trusses into masonry
Use M10 x 100mm

2. Sit Product on Gallow Brackets



4. Fix through Gallow brackets into underside of Canopy
Use M8 x 80mm + Caps

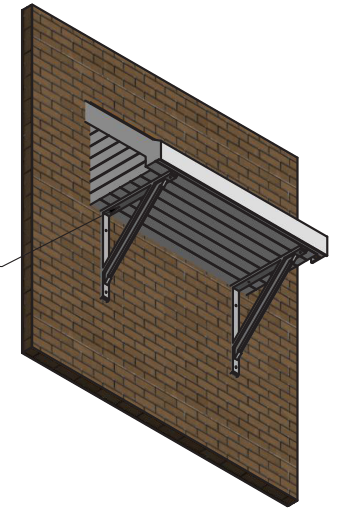

GRP general tolerance unless otherwise stated to be +/- 5mm per 1000mm length.

Masonry Solutions

Tel +44(0)1827 250236
Fax +44(0)1827 280765

technical@masonrysolutions.co.uk
www.masonrysolutions.co.uk

Copyright Masonry Solutions 2013
Company Registration No. 5190844.

Information

Fitting Details Trussed Canopy
with Gallow Brackets

DESIGNED BY peterms	CHECKED BY	APPROVED BY	DATE	DATE 31/07/2013	Drawing Type FD
------------------------	------------	-------------	------	--------------------	--------------------

Trussed Canopy

Fitting Details

With Gallow Brackets

ISSUE
SHEET
1 / 1

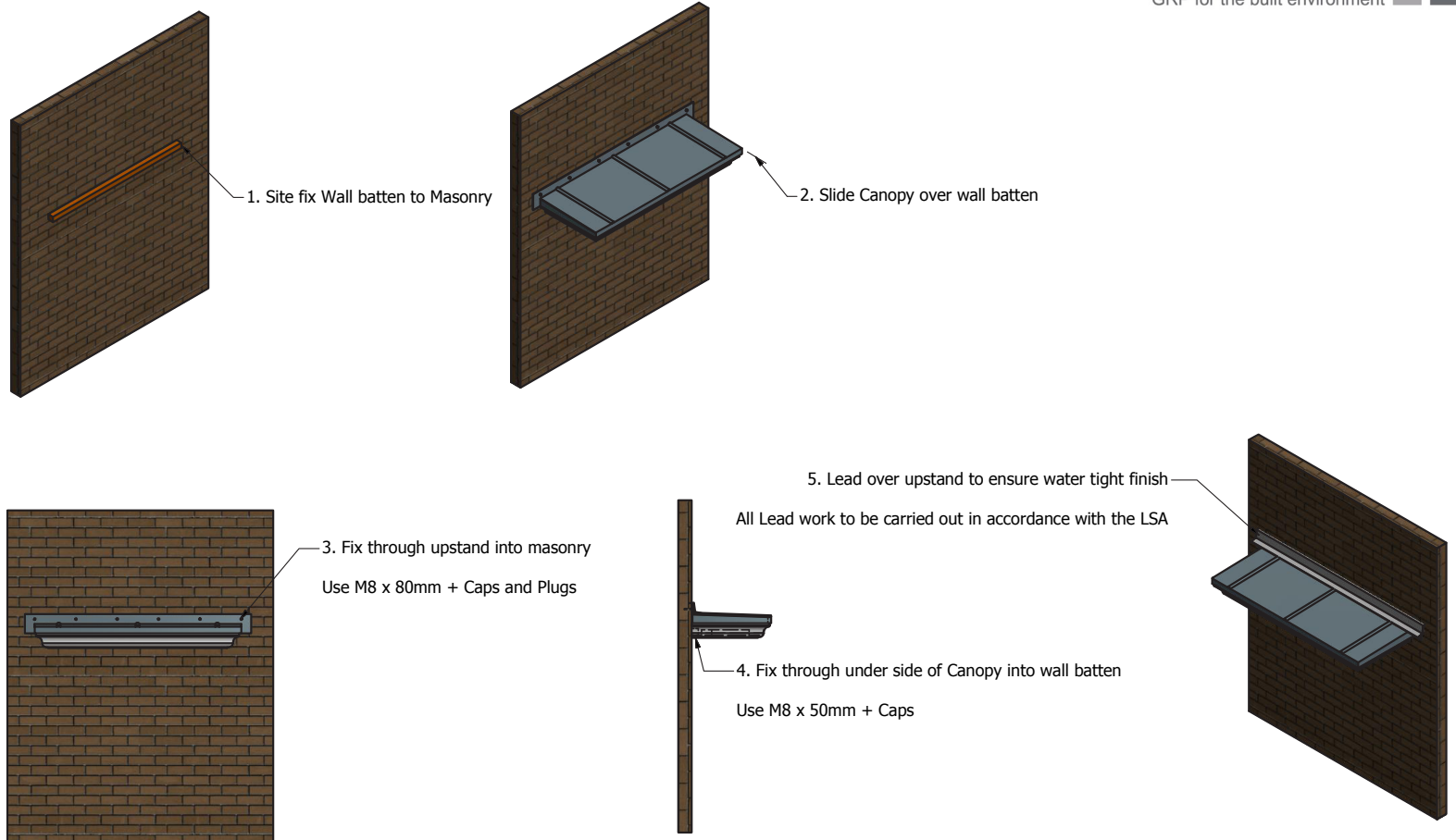

GRP general tolerance unless otherwise stated to be +/- 5mm per 1000mm length.

Masonry Solutions Tel +44(0)1827 250236 Fax +44(0)1827 280765 technical@masonrysolutions.co.uk www.masonrysolutions.co.uk Copyright Masonry Solutions 2013 Company Registration No. 5190844.	Information		DESIGNED BY	CHECKED BY	APPROVED BY	DATE	DATE	Drawing Type	
	Canopy with Lid		peterms				31/07/2013	FD	
			Canopy with Lid			Fitting Details			
						Flat top	ISSUE	SHEET	1 / 1

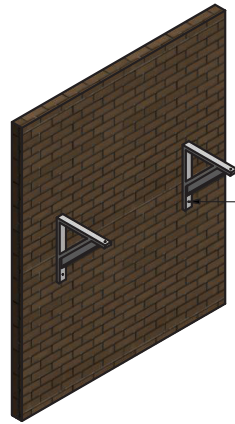

1. Fix Gallows Brackets to wall
Use M10 x 100mm + Caps and Plugs

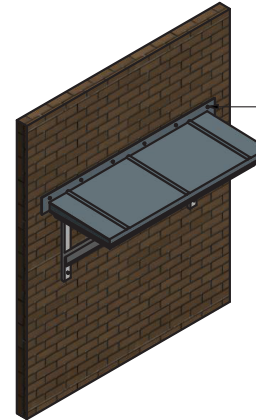

2. Place Canopy on Gallows Brackets
and fix through upstand into Masonry
Use M8 x 80mm + Caps and Plugs

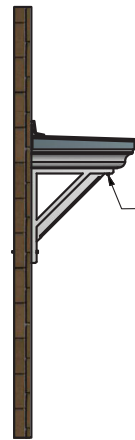

3. Fix through Gallows Brackets into underside of canopy
Use M8 x 50mm + Caps

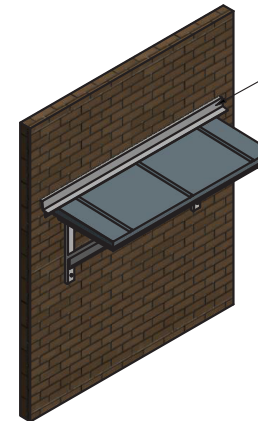

4. Lead over upstand to ensure water tight finish
All lead work needs to be carried out to the LSA guidelines

GRP general tolerance unless otherwise stated to be +/- 5mm per 1000mm length.

Masonry Solutions

Tel +44(0)1827 250238
Fax +44(0)1827 280765

technical@masonrysolutions.co.uk
www.masonrysolutions.co.uk

Copyright Masonry Solutions 2013
Company Registration No. 5190844.

Information

Canopy with Lid
Gallows Brackets

DESIGNED BY peterms	CHECKED BY	APPROVED BY	DATE	DATE 31/07/2013	Drawing Type FD
------------------------	------------	-------------	------	--------------------	--------------------

Canopy with Lid

Fitting Details

Gallows Brackets

ISSUE
SHEET
1 / 1

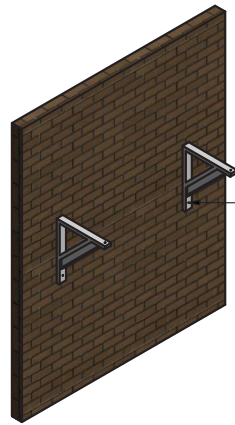

1. Fix Gallow's Brackets to wall
Use M10 x 100mm + Caps and Plugs

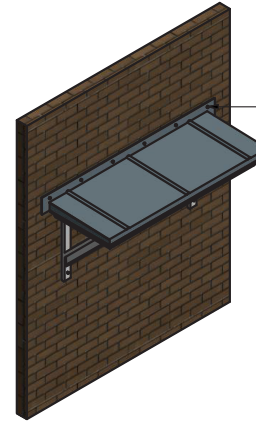

2. Place Canopy on Gallow's Brackets
and fix through upstand into Masonry
Use M8 x 80mm + Caps and Plugs

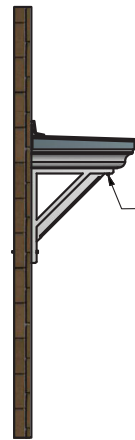

3. Fix through Gallow's Brackets into underside of canopy
Use M8 x 50mm + Caps

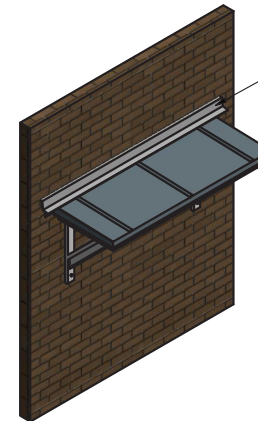

4. Lead over upstand to ensure water tight finish
All lead work needs to be carried out to the LSA guidelines

GRP general tolerance unless otherwise stated to be +/- 5mm per 1000mm length.

Masonry Solutions

Tel +44(0)1827 250238
Fax +44(0)1827 280765

technical@masonrysolutions.co.uk
www.masonrysolutions.co.uk

Copyright Masonry Solutions 2013
Company Registration No. 5190844.

Information

Canopy with Lid
Gallow's Brackets

DESIGNED BY peterms	CHECKED BY	APPROVED BY	DATE	DATE 31/07/2013	Drawing Type FD
------------------------	------------	-------------	------	--------------------	--------------------

Canopy with Lid

Fitting Details

Gallow's Brackets

ISSUE
SHEET
1 / 1

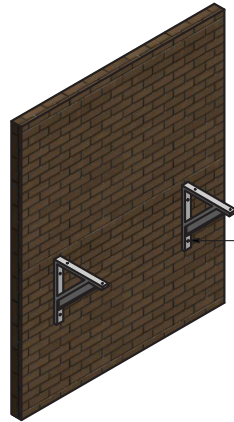

1. Fix Gallows Brackets to masonry
Use M10 x 100mm + Caps and Plugs

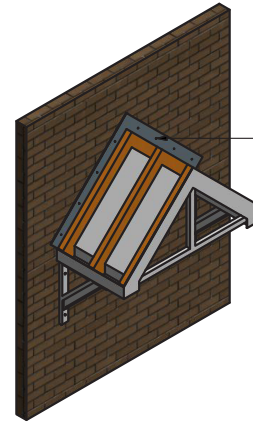

2. Sit Canopy on Gallows Brackets and fix through upstand
Use M8 x 80mm + Caps and Plugs

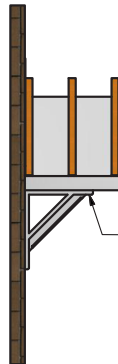

3. Fix through Gallows Bracket into underside of canopy
Use M8 x 50mm + Caps and Plugs

4. Tile and lead over upstand to ensure water tight finish
All lead work needs to be carried out in accordance with LSA guidelines

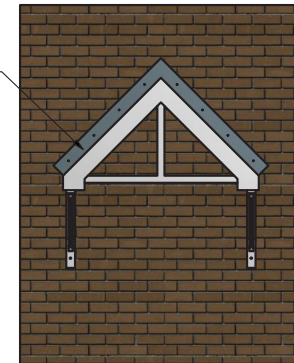

GRP general tolerance unless otherwise stated to be +/- 5mm per 1000mm length.

Masonry Solutions

Tel +44(0)1827 230238
Fax +44(0)1827 230765
technical@masonrysolutions.co.uk
www.masonrysolutions.co.uk
Copyright Masonry Solutions 2013
Company Registration No. 5190844.

Information

Apex Canopy Fitting Details

DESIGNED BY peterms	CHECKED BY	APPROVED BY	DATE	DATE 01/08/2013	Drawing Type FD
------------------------	------------	-------------	------	--------------------	--------------------

Apex Canopy

Fitting Details

Gallows Brackets	ISSUE	SHEET 1 / 1
------------------	-------	----------------

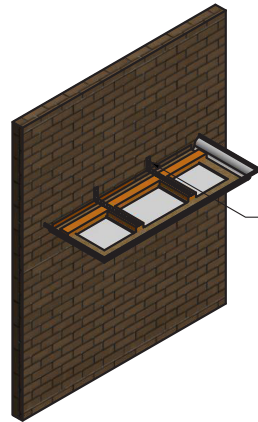

1. Fix base unit to wall via glassed in strong ties
Use M8 x 80mm

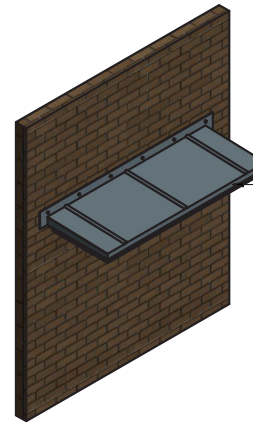

2. Place lid on base unit and fix through face into base unit
Use fir tree fixings provided

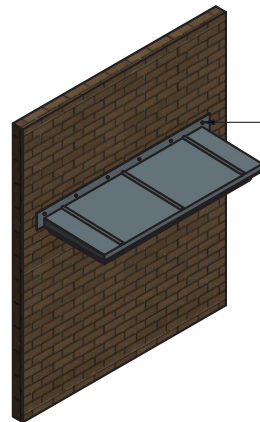

3. Fix through upstand into masonry
Use M8 x 80mm + Caps and Plugs

4. Lead over upstand to ensure watertight finish
All lead work needs to be carried out in accordance with LSA guidelines

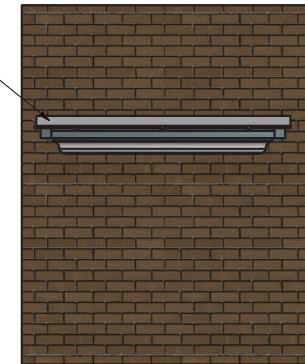

GRP general tolerance unless otherwise stated to be +/- 5mm per 1000mm length.

Masonry Solutions

Tel +44(0)1827 230238
Fax +44(0)1827 230765
technical@masonrysolutions.co.uk
www.masonrysolutions.co.uk
Copyright Masonry Solutions 2013
Company Registration No. 5190844.

Information

Site Address
Plot No.

DESIGNED BY peterms	CHECKED BY	APPROVED BY	DATE	DATE 01/08/2013	Drawing Type FD
------------------------	------------	-------------	------	--------------------	--------------------

Canopy Standard

Fitting Details

Strong Ties	ISSUE	SHEET 1 / 1
-------------	-------	----------------

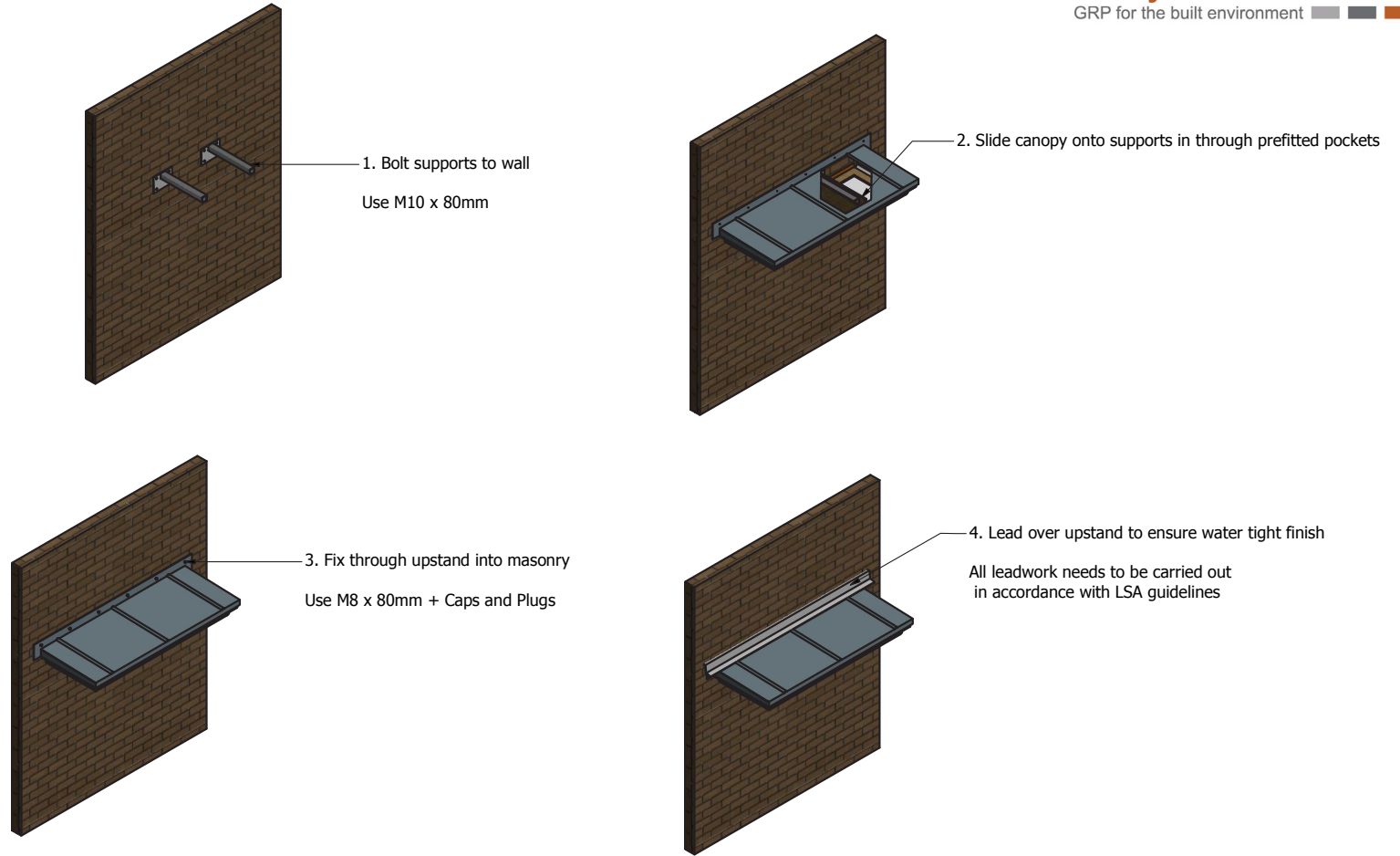

GRP general tolerance unless otherwise stated to be +/- 5mm per 1000mm length.

Masonry Solutions Tel +44(0)1827 250238 Fax +44(0)1827 280765 technical@masonrysolutions.co.uk www.masonrysolutions.co.uk Copyright Masonry Solutions 2013 Company Registration No. 5190844.	Information		DESIGNED BY	CHECKED BY	APPROVED BY	DATE	DATE	Drawing Type	
	Canopy with Lid		peterms				01/08/2013	FD	
	Canopy Support		Canopy with Lid			Fitting Details			
			Canopy Support	ISSUE	SHEET	1 / 1			

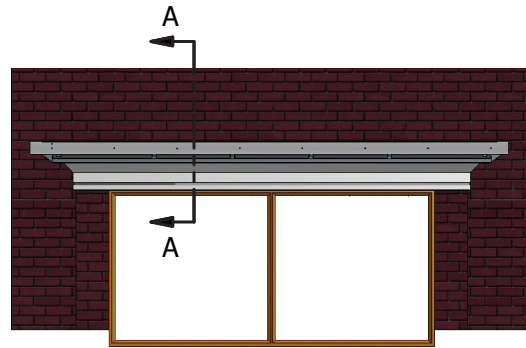

4. fix through 100mm upstand into brick wall

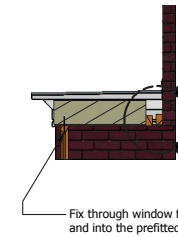
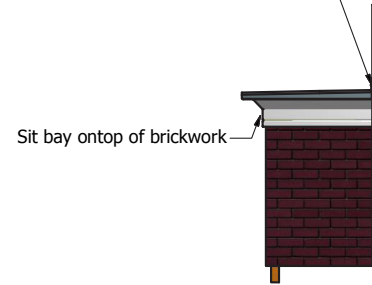

SECTION A-A
SCALE 1:33

5. Lead over upstand to ensure water tight fixing

All Leadwork to be carried out in accordance with LSA guidelines

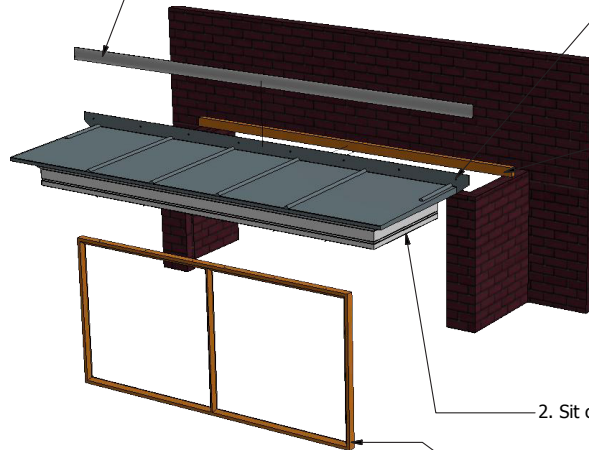

4. fix through 100mm upstand into brick wall

Use M8 x 80mm + Caps and Plugs

1. Site supplied and Fixed wall batten

2. Sit canopy on bay and side over wall batten

3. Fix through window frame into underside of bay.

Use 8 x 50mm wood screws

DETAIL B
SCALE 0.06 : 1



site supplied and fitted wall batten 3 x 2

Fix through underside of canopy into wall batten
Washers must be used to prevent fixing pulling through GRP



GRP general tolerance unless otherwise stated to be +/- 5mm per 1000mm length.

Masonry Solutions

Tel +44(0)1827 250238
Fax +44(0)1827 280765
technical@masonrysolutions.co.uk
www.masonrysolutions.co.uk
Copyright Masonry Solutions 2013
Company Registration No. 5190844.

Information	
Bay Window Fixing Details	
Square Bay	

DESIGNED BY	CHECKED BY	APPROVED BY	DATE	DATE	Drawing Type
peternms				04/06/2013	FD
Bay Canopy			Fitting Details		
			Standard Square	ISSUE A	SHEET 1 / 1

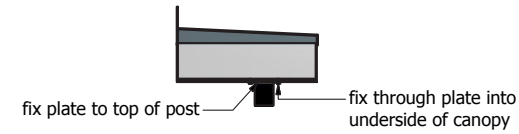
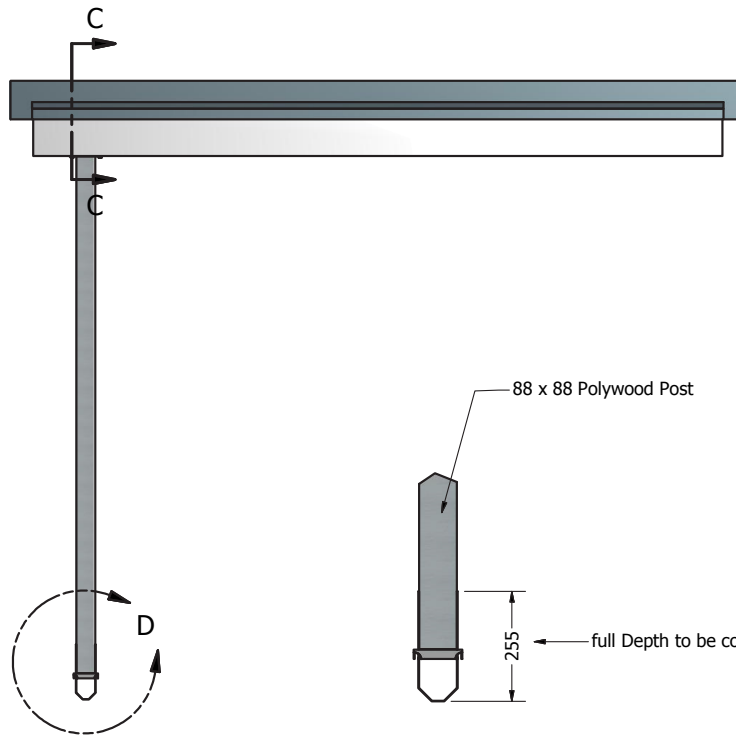

SECTION C-C
SCALE 1:20

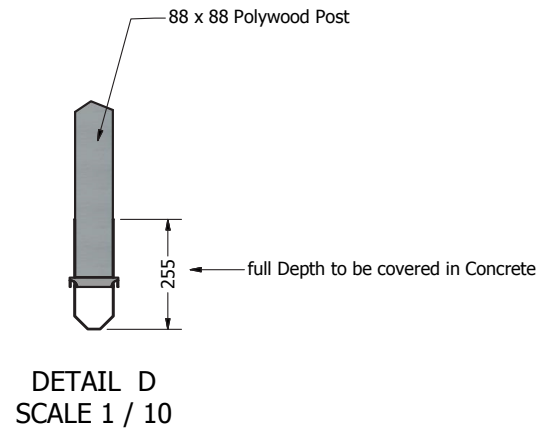
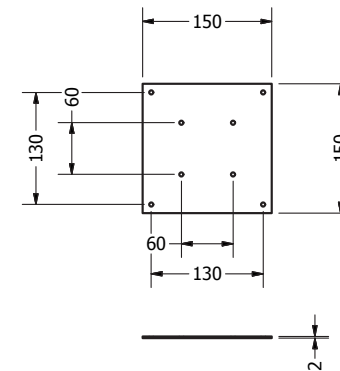

Masonry Solutions

Cedar Park, Ninian Way, Tame Valley Industrial Estate,
Tamworth B77 5DE.

Tel +44(0)1827 250236
Fax +44(0)1827 280765

Copyright Masonry Solutions 2013
Company Registration No. 5190844.

Technical@masonrysolutions.co.uk
www.masonrysolutions.co.uk

DESIGNED BY peterms	CHECKED BY	APPROVED BY	DATE	DATE 15/04/2013	Drawing Type FD
				Masonry Solutions Fixing Plate	
				88mm Post Fixing Detail	

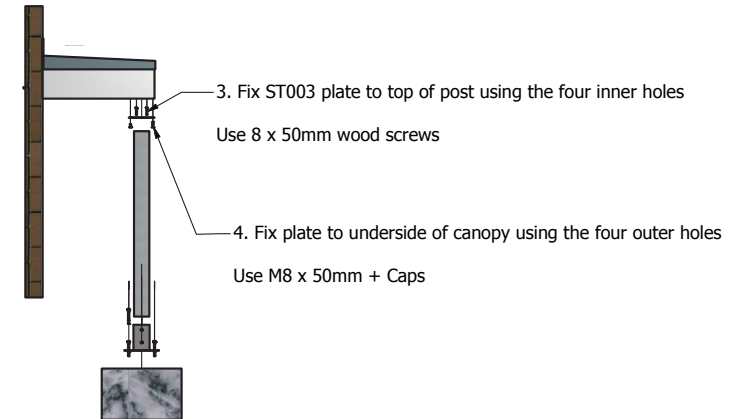
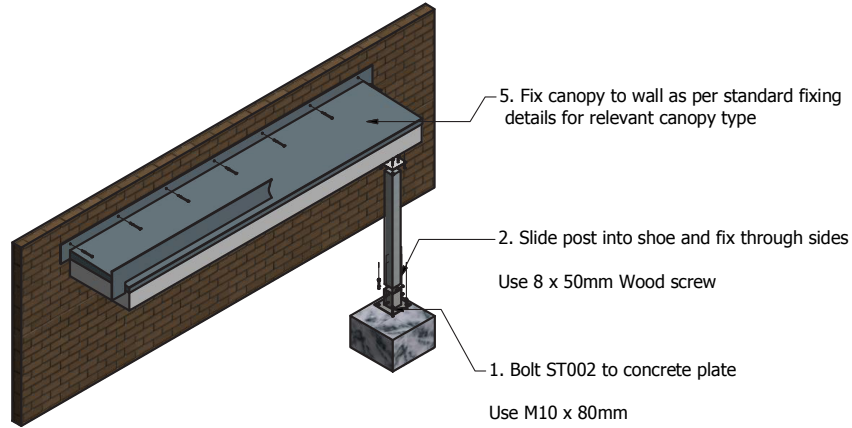

GRP general tolerance unless otherwise stated to be +/- 5mm per 1000mm length.

Masonry Solutions

Tel +44(0)1827 250238
Fax +44(0)1827 280765

technical@masonrysolutions.co.uk
www.masonrysolutions.co.uk

Copyright Masonry Solutions 2013
Company Registration No. 5190844.

Information

Canopy or Bay with Post

ST002 + ST003

DESIGNED BY peterms	CHECKED BY	APPROVED BY	DATE	DATE 01/08/2013	Drawing Type FD
------------------------	------------	-------------	------	--------------------	--------------------

Canopy or Bay with Post

Fitting Details

ST002 + ST003

ISSUE
SHEET
1 / 1

masonry solutions

GRP for the built environment



Dormers

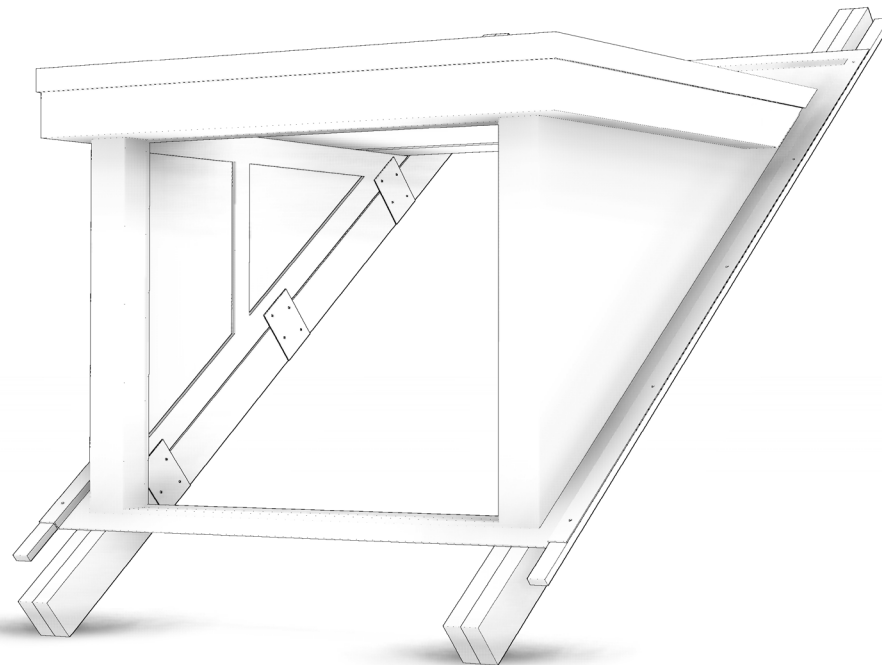

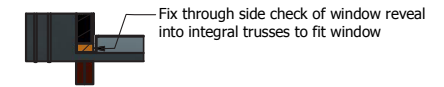
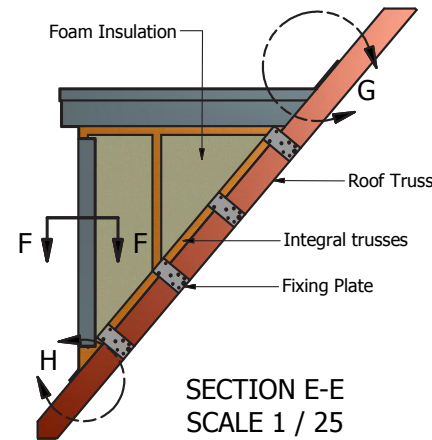
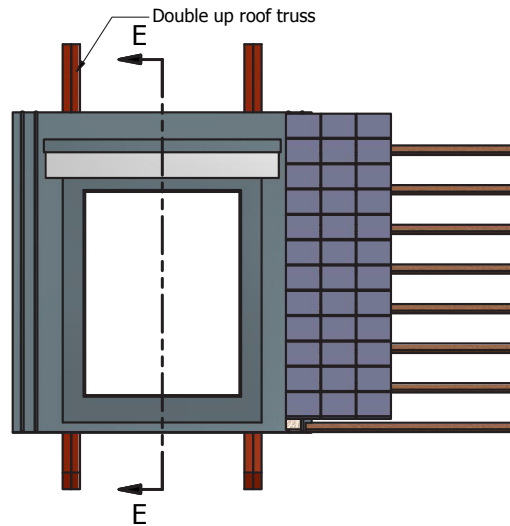

SECTION F-F
SCALE 1 / 25

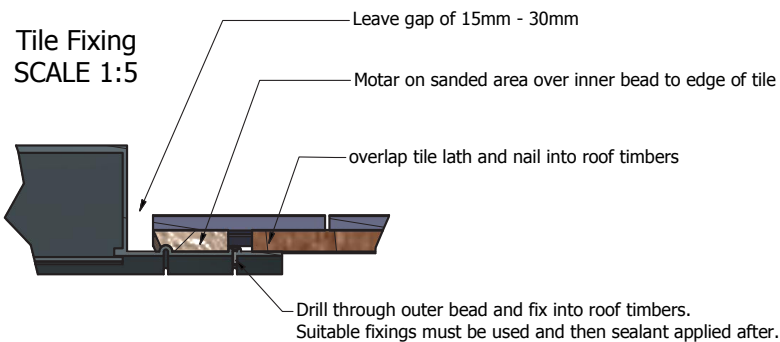

Alternatively you can ask Masonry Solutions to quote a Dormer Fixing Kit

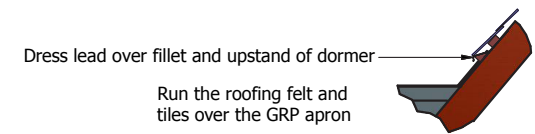

DETAIL G
SCALE 1:20

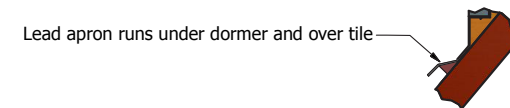

DETAIL H
SCALE 1:20

GRP general tolerance unless otherwise stated to be +/- 5mm per 1000mm length.

Masonry Solutions

Tel +44(0)1827 250238
Fax +44(0)1827 280765
technical@masonrysolutions.co.uk
www.masonrysolutions.co.uk

Copyright Masonry Solutions 2013
Company Registration No. 5190844.

Information

Fitting Detail Dormer

Double Rain Channel

DESIGNED BY
peterms

CHECKED BY

APPROVED BY

DATE

DATE
22/04/2013

Drawing Type
FD

FLAT TOP DORMER

Fitting Detail

MORTAR TILED

ISSUE
A

SHEET
1 / 1

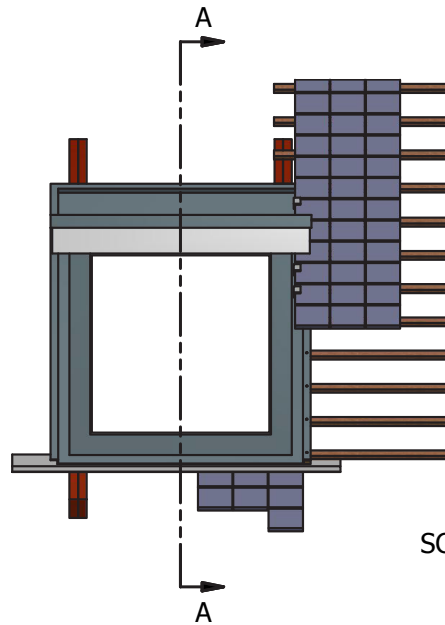

C - C
SCALE 1:15

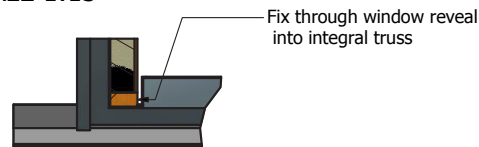

SECTION B-B
SCALE 1:25

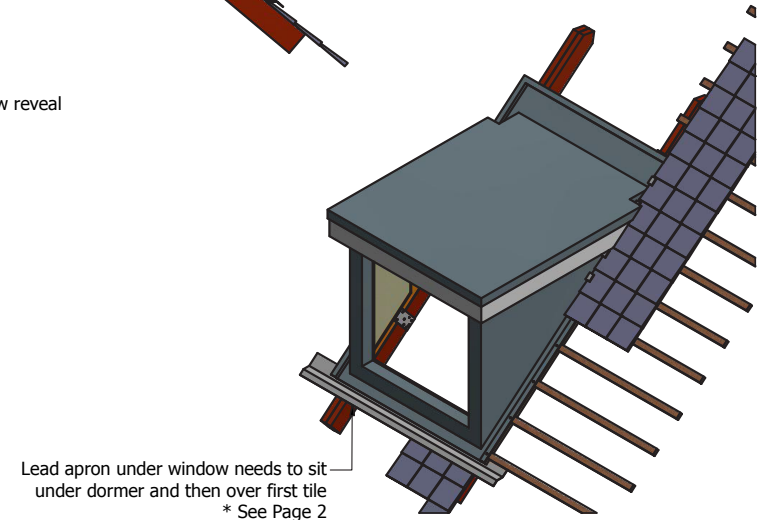
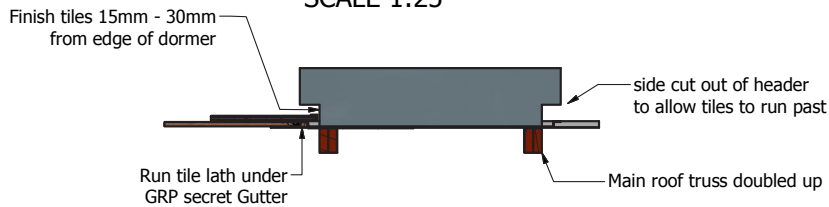

Lead apron under window needs to sit under dormer and then over first tile
* See Page 2

GRP general tolerance unless otherwise stated to be +/- 5mm per 1000mm length.

Masonry Solutions

Tel +44(0)1827 280238
Fax +44(0)1827 280765

technical@masonrysolutions.co.uk
www.masonrysolutions.co.uk

Copyright Masonry Solutions 2013
Company Registration No. 5190844.

Information

Fitting Details Dormer

Secret Gutter

DESIGNED BY

peterms

CHECKED BY

APPROVED BY

DATE

DATE

22/04/2013

Drawing Type

FD

Dormer

Fitting Details

Secret Gutter

ISSUE

A

SHEET

1 / 2

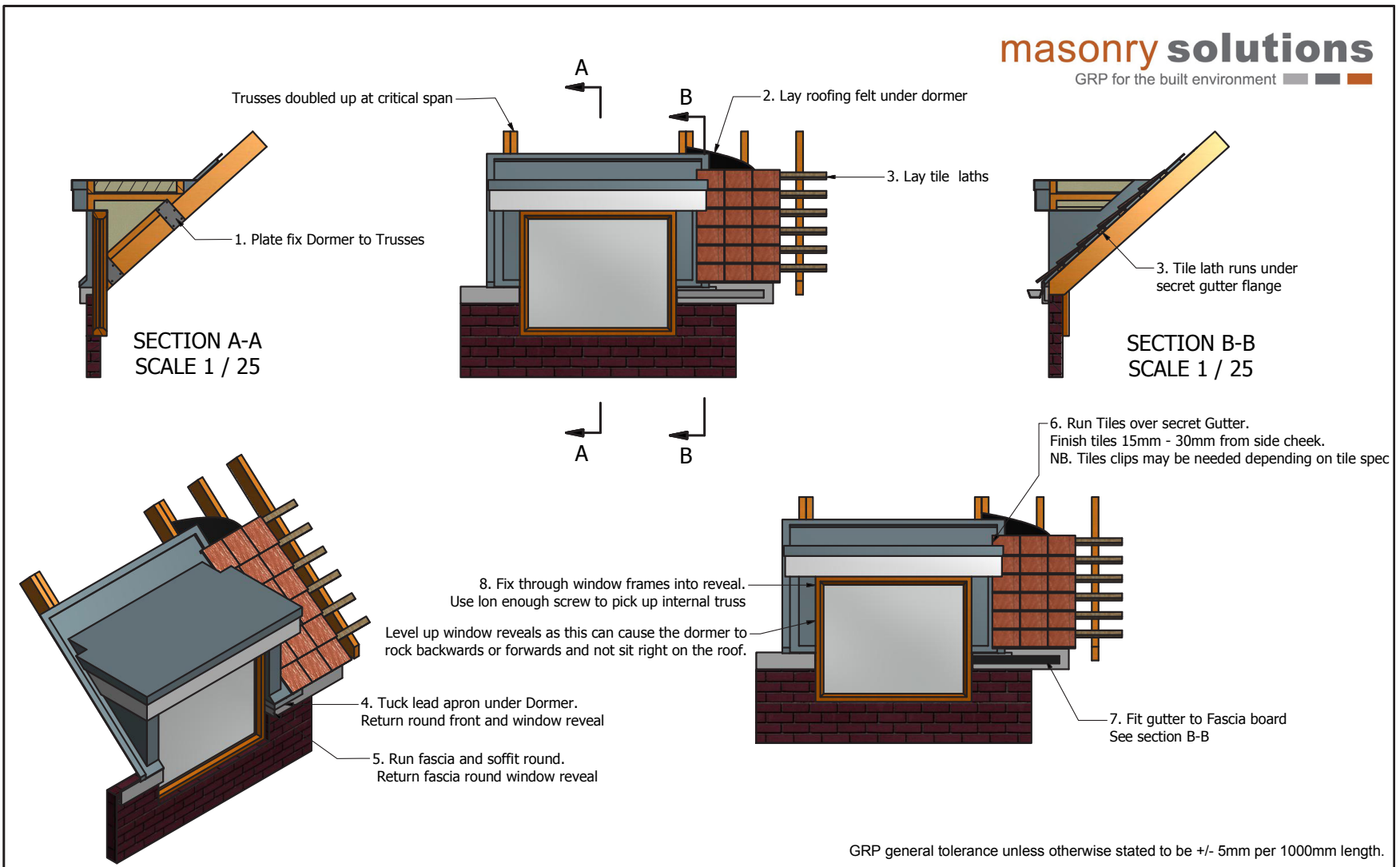

Masonry Solutions Tel +44(0)1827 280238 Fax +44(0)1827 280765 technical@masonrysolutions.co.uk www.masonrysolutions.co.uk Copyright Masonry Solutions 2013 Company Registration No. 5190844.	Information			DESIGNED BY	CHECKED BY	APPROVED BY	DATE	DATE	Drawing Type
	Fixing Details	REVISION HISTORY	DATE	peterms			02/09/2013	02/09/2013	FD
	Half Dormer	DESCRIPTION	DATE	Half Dormer			Fixing Detail		
		New Drawing	02/09/2013	Fixing Detail - Half Dormer			ISSUE	SHEET	

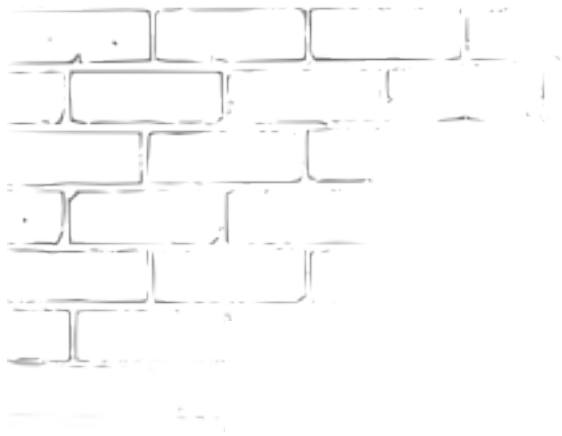

masonry solutions

GRP for the built environment

Window Surrounds

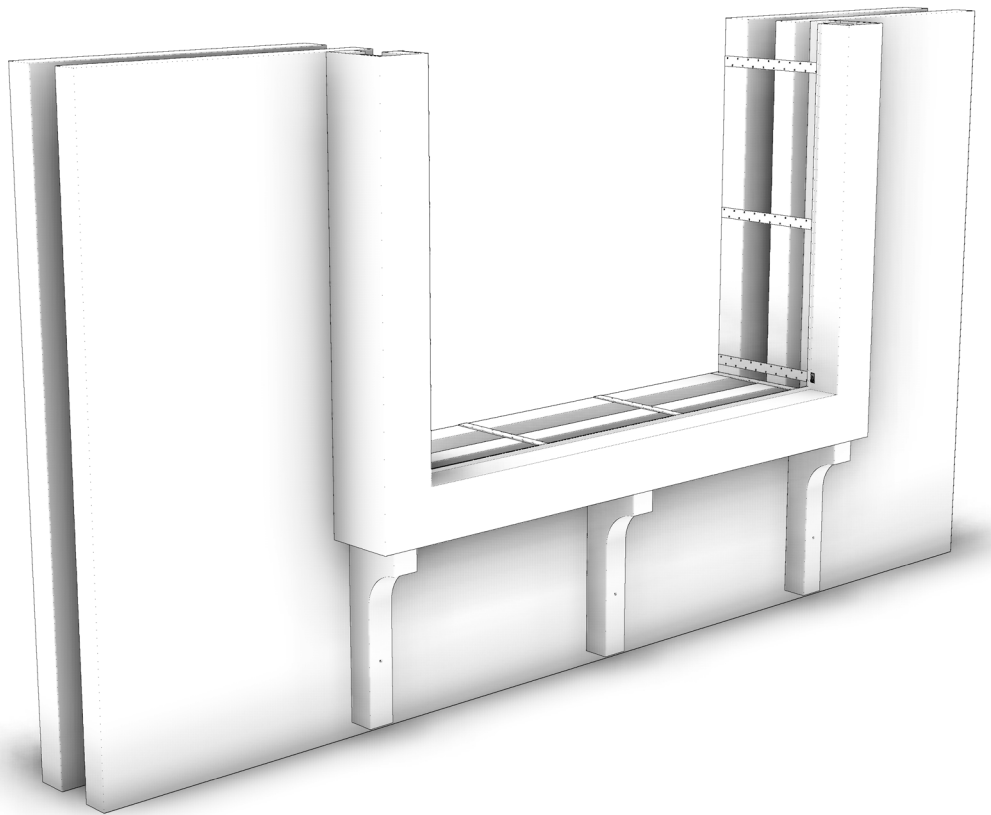

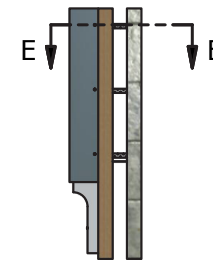
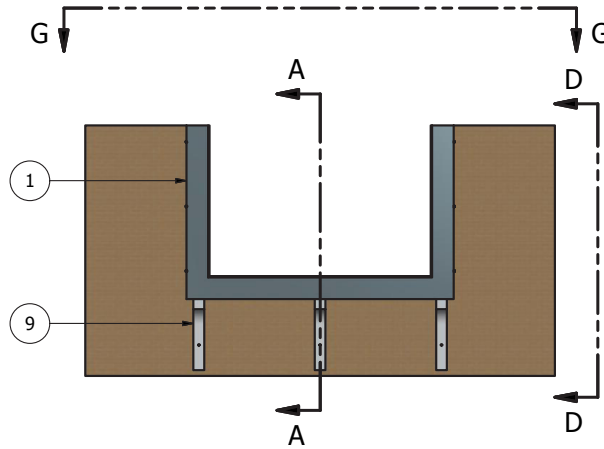

VIEW D-D
SCALE 1 / 30



SECTION A-A
SCALE 1 / 30

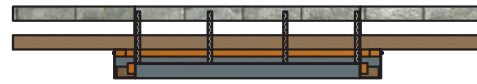

VIEW G-G
SCALE 1 / 30

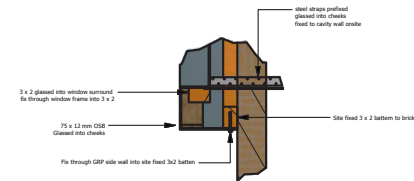

DETAIL E
SCALE 1 / 15

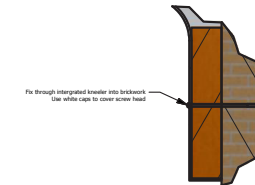

DETAIL C
SCALE 1:10

GRP general tolerance unless otherwise stated to be +/- 5mm per 1000mm length.

Masonry Solutions

Tel +44(0)1827 250238
Fax +44(0)1827 280765

technical@masonrysolutions.co.uk
www.masonrysolutions.co.uk

Copyright Masonry Solutions 2013
Company Registration No. 5190844.

Information	
Fitting Details Window Surround	

DESIGNED BY	CHECKED BY	APPROVED BY	DATE	DATE	Drawing Type
Pmanmax				03/04/2013	FD
Window Surround			Fitting Details		
			Standard	ISSUE A	SHEET 1 / 2

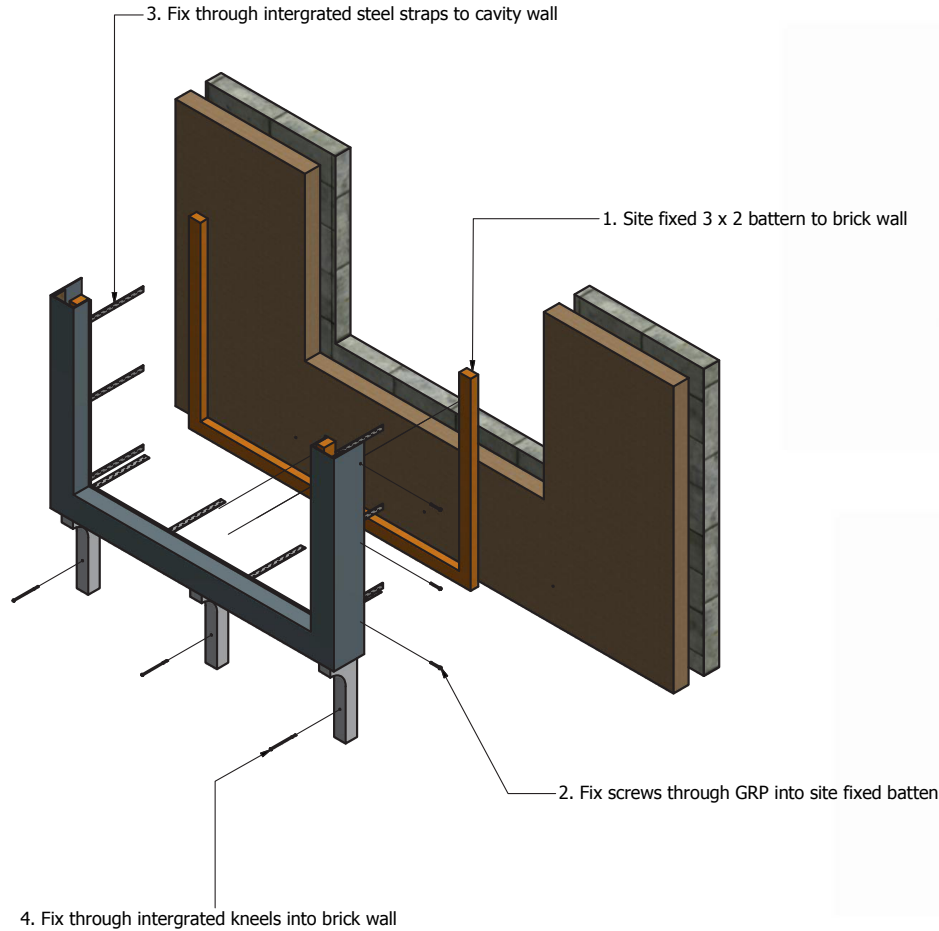

GRP general tolerance unless otherwise stated to be +/- 5mm per 1000mm length.

Masonry Solutions Tel +44(0)1827 250236 Fax +44(0)1827 280765 technical@masonrysolutions.co.uk www.masonrysolutions.co.uk Copyright Masonry Solutions 2013 Company Registration No. 5190844.	Information		DESIGNED BY	CHECKED BY	APPROVED BY	DATE	DATE	Drawing Type
	Site Address		Pmanmax				03/04/2013	FD
	Plot No.		Window Surround			Fitting Details		
			Standard			ISSUE	SHEET	
					A		2 / 2	



If you have any questions about our fitting details or if the product we have supplied you isn't featured in this pack please don't hesitate to call us on

01827 250236 or email cad@masonrysolutions.co.uk

Many Thanks



masonry solutions

GRP for the built environment ■ ■ ■

Fitting Details